



EN Operating instructions.pages 1 to 6
Original

Content

1 About this document

1.1 Function 1

1.2 Target group: authorised qualified personnel. 1

1.3 Explanation of the symbols used 1

1.4 Appropriate use 1

1.5 General safety instructions 1

1.6 Warning about misuse 1

1.7 Exclusion of liability 2

2 Product description

2.1 Ordering code 2

2.2 Special versions. 2

2.3 Purpose 2

2.4 Technical Data 3

3 Assembly

3.1 Dimensions 3

4 Electrical connection

4.1 General information for electrical connection. 3

4.2 Contact Options 3

5 Set-up and maintenance

5.1 Functional testing. 4

5.2 Maintenance 4

6 Disassembly and disposal

6.1 Disassembly. 4

6.2 Disposal 4

7 EU Declaration of conformity

1. About this document

1.1 Function

This operating instructions manual provides all the information you need for the mounting, set-up and commissioning to ensure the safe operation and disassembly of the foot switch. The operating instructions must be available in a legible condition and a complete version in the vicinity of the device.

1.2 Target group: authorised qualified personnel

All operations described in this operating instructions manual must be carried out by trained specialist personnel, authorised by the plant operator only.

Please make sure that you have read and understood these operating instructions and that you know all applicable legislations regarding occupational safety and accident prevention prior to installation and putting the component into operation.

The machine builder must carefully select the harmonised standards to be complied with as well as other technical specifications for the selection, mounting and integration of the components.

1.3 Explanation of the symbols used



Information, hint, note:
This symbol indicates useful additional information.



Caution: Failure to comply with this warning notice could lead to failures or malfunctions.
Warning: Failure to comply with this warning notice could lead to physical injury and/or damage to the machine.

1.4 Appropriate use

The Schmersal range of products is not intended for private consumers.

The product must be exclusively used in accordance with the versions listed below or for the applications authorised by the manufacturer. Detailed information regarding the range of applications can be found in the chapter "Product description".

1.5 General safety instructions

The user must observe the safety instructions in this operating instructions manual, the country specific installation standards as well as all prevailing safety regulations and accident prevention rules.



Further technical information can be found in the Schmersal catalogues or in the online catalogue on the Internet: products.schmersal.com.

The information contained in this operating instructions manual is provided without liability and is subject to technical modifications.

There are no residual risks, provided that the safety instructions as well as the instructions regarding mounting, commissioning, operation and maintenance are observed.

1.6 Warning about misuse



In case of inadequate or improper use or manipulations of the foot switch, personal hazards or damage to machinery or plant components cannot be excluded.

1.7 Exclusion of liability

We shall accept no liability for damages and malfunctions resulting from defective mounting or failure to comply with this operating instructions manual. The manufacturer shall accept no liability for damages resulting from the use of unauthorised spare parts or accessories.

For safety reasons, invasive work on the device as well as arbitrary repairs, conversions and modifications to the device are strictly forbidden, the manufacturer shall accept no liability for damages resulting from such invasive work, arbitrary repairs, conversions and/or modifications to the device.

2. Product description

2.1 Ordering code

This operating instructions manual applies to the following types:

①F② 232-③-④		with 1 foot pedal
No.	Option	Description
①	T	Slow action
	Z	Snap action
②		without protective shield
	H	with protective shield
③	11	1 NO / 1 NC
	02	2 NC
	20	2 NO
	22	2 NO / 2 NC
	04	4 NC
	40	4 NO
④	HD	Staggered contacts with pressure point
	F	Bi-stable function

①2F② 232-③-④		with 2 foot pedals
No.	Option	Description
①	T	Slow action
	Z	Snap action
②		without protective shield
	H	with protective shield
③		per pedal:
	11/11	1 NO / 1 NC
	02/02	2 NC
	20/20	2 NO
	22/22	2 NO / 2 NC
	04/04	4 NC
40/40	4 NO	
④	HD	Staggered contacts with pressure point

2.2 Special versions

For special versions, which are not listed in the order code below 2.1, these specifications apply accordingly, provided that they correspond to the standard version.

2.3 Purpose

These robust foot switches are particularly suitable for industrial applications. They are equipped with slow or snap action switch inserts. The foot switches with ordering suffix H are mounted with a shield to protect against unintentional actuation.

Staggered operating principle (ordering suffix -HD)

The staggering is realised by means of a pressure point, which is installed under the pedal. When the foot pedal is actuated as far as the pressure point, 1 NO contact is closed. If the pedal is actuated beyond the pressure point, the second NO contact is closed. The first pair of contacts remain enabled.

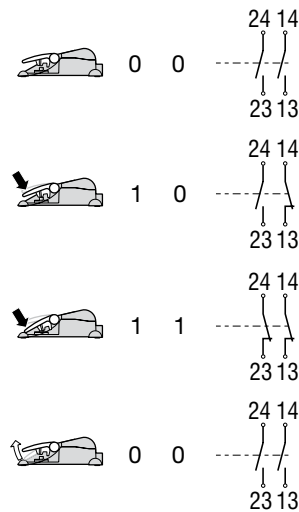

Bi-stable operating principle (ordering suffix -F)

Upon the first foot lever action, the switch insert is switched on (= ON). Upon the second foot lever action, the latching of the switching elements is neutralised, i.e. the switch insert is switched off by the spring in the switch insert (= OFF) (push/push function).

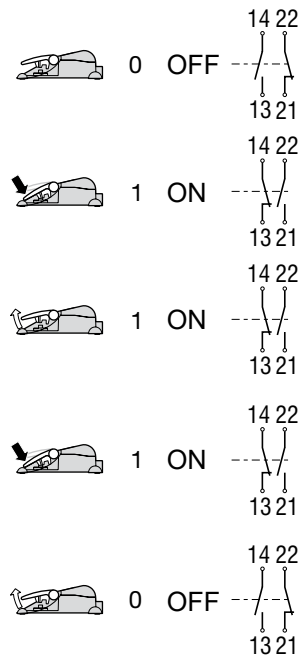

2.4 Technical Data

Standards:	EN 60947-5-1
Enclosure/cap/cover:	Aluminium die-cast, powder-coated
Pedal:	glass-fibre reinforced thermoplastic
Cable entry:	1-pedal: 1 x M20 2-pedal: 2 x M25
Degree of protection:	IP65 to EN 60529
Switching system:	
- slow action:	1 NC / 1 NO, 2 NO, 2 NC
- snap action:	1 NC / 1 NO, 2 NC
Execution of the electrical connection:	screw terminals
Cable section:	max. 2.5 mm ² (incl. conductor ferrules)
Utilisation category:	AC-15 / DC-13
Rated operating current/voltage I _e /U _e :	4 A / 230 VAC 1 A / 24 VDC
Rated impulse withstand voltage U _{imp} :	6 kV
Rated insulation voltage U _i :	500 V
Thermal test current I _{the} :	10 A
Required short-circuit current:	1,000 A
Max. fuse rating:	6 A gG D-fuse (EN 60269-1)
Ambient temperature:	-25 °C ... +70 °C
Mechanical life:	> 1 million operations



Openings shall be closed by equipment rated for enclosure types: 3, 3R, 3RX, 3S, 3SX, 3X, 5, 4, 4X, 6, 6P, 12 or 13. Use 105°C wires/cables only.

3. Assembly

3.1 Dimensions

All measurements in mm.

TF(H)/ZF(H), 1 foot pedal

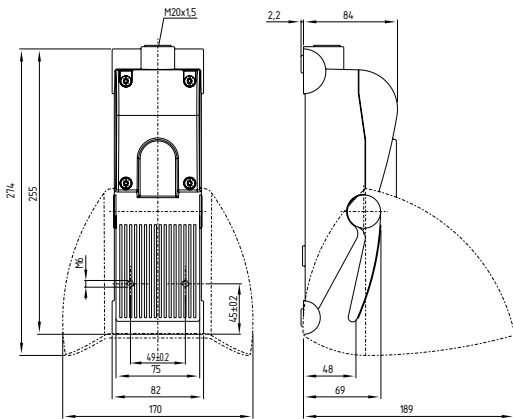

T2F(H)/Z2F(H), 2 foot pedals

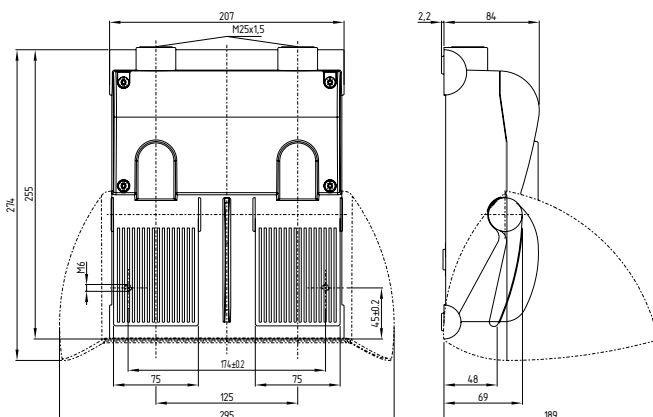

4. Electrical connection

4.1 General information for electrical connection



The electrical connection may only be carried out by authorised personnel in a de-energised condition.

The contact labelling can be found in the wiring compartment of the switch. For the cable entry, suitable cable glands with an appropriate degree of protection must be used. The cables must be laid correctly in the wiring compartment of the switch. For foot switches with 1 foot pedal, the M20 x 1.5 cable entry is available, for foot switches with 2 foot pedals, 2x M25 x 1.5. The non-used cable entry must be sealed with blanking plugs.

Settle length x of the conductor: 6 mm



After wiring, the wiring compartment of the switch must definitely be cleaned (e.g. removal of cables residues), considering that foreign bodies can affect the switching behaviour. The tightening torque for the cover screws is min. 1.8 Nm.

4.2 Contact Options

The contacts are shown in a non-actuated condition.

with 1 foot pedals

TF 232-11, TFH 232-11,
ZF 232-11, ZFH 232-11

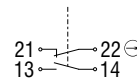

TF 232-02, TFH 232-02,
ZF 232-02, ZFH 232-02

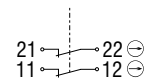

TF 232-20, TFH 232-20

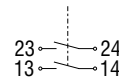

TF 232-22, TFH 232-22,
ZF 232-22, ZFH 232-22

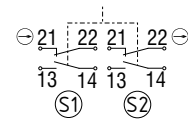

TF 232-04, TFH 232-04,
ZF 232-04, ZFH 232-04

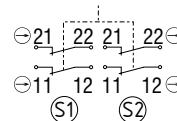

TF 232-40, TFH 232-40

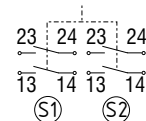

with 2 foot pedals

T2F 232-11/11, T2FH 232-11/11,
Z2F 232-11/11, Z2FH 232-11/11



T2F 232-02/02, T2FH 232-02/02,
Z2F 232-02/02, Z2FH 232-02/02



T2F 232-20/20,
T2FH 232-20/20



T2F 232-22/22, T2FH 232-22/22,
Z2F 232-22/22, Z2FH 232-22/22



T2F 232-04/04, T2FH 232-04/04,
Z2F 232-04/04, Z2FH 232-04/04

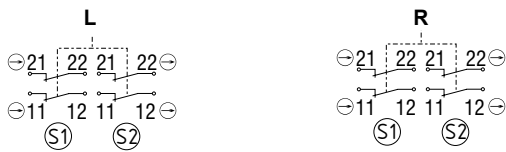

T2F 232-40/40, T2FH 232-40/40



Key

- ⊖ Positive break NC contact
- L left pedal
- R right pedal

5. Set-up and maintenance

5.1 Functional testing

The function of the component must be tested. The following conditions must be previously checked and met:

1. Check the integrity of the cable entry and connections
2. Check the switch enclosure for damage
3. Check the functionality of the switch by actuating the foot switch

5.2 Maintenance

The function (switching) of the foot switch must be tested in regular intervals. Possible soiling accumulated below the foot pedal must be removed.

A regular visual inspection and functional test, including the following steps, is recommended:

- Check the switch enclosure for damages
- Check the cable entries and the wire connections

Damaged or defective components must be replaced.

6. Disassembly and disposal

6.1 Disassembly

The product must be disassembled in a de-energised condition only.

6.2 Disposal

The product must be disposed of in an appropriate manner in accordance with the national prescriptions and legislations.

7. EU Declaration of conformity

EU Declaration of conformity



Original
ACE Schmersal
Eletrônica Industrial Ltda.
Av. Brasil, nº 815
Jardim Esplanada
CEP: 18557-646 Boituva – SP
Brasil
Internet: www.schmersal.com.br

We hereby certify that the hereafter described components both in their basic design and construction conform to the applicable European Directives.

Name of the component: Z/TF 232

Type: See ordering code

Description of the component: Foot switch

Relevant Directives: 2014/35/EU Low Voltage Directive
2011/65/EU RoHS-Directive

Applied standards: EN 60947-5-1:2017

Person authorised for the compilation of the technical documentation: Oliver Wacker
Mödinghofe 30
42279 Wuppertal

Place and date of issue: Boituva, April 7, 2022

Authorised signature
Marco Antonio De Dato
Head of Engineering and Design

ACE-ZTF232-D-EN



The currently valid declaration of conformity can be downloaded from the internet at products.schmersal.com.



K.A. Schmersal GmbH & Co. KG
Möddinghofe 30, 42279 Wuppertal
Germany

Phone: +49 202 6474-0
Telefax: +49 202 6474-100
E-mail: info@schmersal.com
Internet: www.schmersal.com

Production site:

ACE Schmersal

Eletrônica Industrial Ltda.

Av. Brasil, nº 815

Jardim Esplanada – CEP: 18557-646, Boituva – SP

Brasil

Phone: +55 - (0)15 - 32 63 - 9866

Telefax: +55 - (0)15 - 32 63 - 9890

E-mail: vendas@schmersal.com.br

Internet: <http://www.schmersal.com.br>