



**EN** Operating instructions. . . . .pages 1 to 6  
Translation of the original operating instructions

**Content**

**1 About this document**

1.1 Function . . . . . 1

1.2 Target group: authorised qualified personnel. . . . . 1

1.3 Explanation of the symbols used . . . . . 1

1.4 Appropriate use . . . . . 1

1.5 General safety instructions . . . . . 1

1.6 Warning about misuse . . . . . 2

1.7 Exclusion of liability . . . . . 2

**2 Product description**

2.1 Ordering code . . . . . 2

2.2 Special versions. . . . . 2

2.3 Destination and use . . . . . 2

2.4 Technical data . . . . . 2

2.5 Safety classification . . . . . 3

**3 Mounting**

3.1 General mounting instructions . . . . . 3

3.2 Dimensions . . . . . 3

**4 Electrical connection**

4.1 General information for electrical connection. . . . . 3

**5 Operating principle and settings**

5.1 LED functions. . . . . 3

5.2 Description of the terminals . . . . . 3

5.3 Notes . . . . . 3

**6 Set-up and maintenance**

6.1 Functional testing. . . . . 4

6.2 Maintenance . . . . . 4

**7 Disassembly and disposal**

7.1 Disassembly. . . . . 4

7.2 Disposal . . . . . 4

**8 Appendix**

8.1 Wiring examples . . . . . 4

8.2 Start configuration . . . . . 4

8.3 Sensor configuration . . . . . 5

8.4 Actuator configuration . . . . . 5

**9 Declaration of conformity**

9.1 EC Declaration of conformity . . . . . 6

**1. About this document**

**1.1 Function**

This operating instructions manual provides all the information you need for the mounting, set-up and commissioning to ensure the safe operation and disassembly of the safety-monitoring module. The operating instructions must be available in a legible condition and a complete version in the vicinity of the device.

**1.2 Target group: authorised qualified personnel**

All operations described in this operating instructions manual must be carried out by trained specialist personnel, authorised by the plant operator only.

Please make sure that you have read and understood these operating instructions and that you know all applicable legislations regarding occupational safety and accident prevention prior to installation and putting the component into operation.

The machine builder must carefully select the harmonised standards to be complied with as well as other technical specifications for the selection, mounting and integration of the components.

**1.3 Explanation of the symbols used**

 **Information, hint, note:**  
This symbol is used for identifying useful additional information.

 **Caution:** Failure to comply with this warning notice could lead to failures or malfunctions.  
**Warning:** Failure to comply with this warning notice could lead to physical injury and/or damage to the machine.

**1.4 Appropriate use**

The products described in these operating instructions are developed to execute safety-related functions as part of an entire plant or machine. It is the responsibility of the manufacturer of a machine or plant to ensure the correct functionality of the entire machinery or plant.

The safety-monitoring module must be exclusively used in accordance with the versions listed below or for the applications authorised by the manufacturer. Detailed information regarding the range of applications can be found in the chapter "Product description".

 To avoid EMC disturbances, the physical ambient and operational conditions at the place where the product is installed, must meet the provisions laid down in the paragraph "Electromagnetic Compatibility (EMC)" of DIN EN 60204-1.

**1.5 General safety instructions**

The user must observe the safety instructions in this operating instructions manual, the country-specific installation standards as well as all prevailing safety regulations and accident prevention rules.

 Further technical information can be found in the Schmersal catalogues or in the online catalogue on the Internet: [www.schmersal.net](http://www.schmersal.net).

The information contained in this operating instructions manual is provided without liability and is subject to technical modifications.



The entire concept of the control system, in which the safety component is integrated, must be validated to EN ISO 13849-2.

There are no residual risks, provided that the safety instructions as well as the instructions regarding mounting, commissioning, operation and maintenance are observed.

### 1.6 Warning about misuse



In case of inadequate or improper use or manipulations of the safety-monitoring module, personal hazards or damage to machinery or plant components cannot be excluded. The relevant requirements of the standards EN 1088 and EN ISO 13850 must be observed.

### 1.7 Exclusion of liability

We shall accept no liability for damages and malfunctions resulting from defective mounting or failure to comply with this operating instructions manual. The manufacturer shall accept no liability for damages resulting from the use of unauthorised spare parts or accessories.

For safety reasons, invasive work on the device as well as arbitrary repairs, conversions and modifications to the device are strictly forbidden; the manufacturer shall accept no liability for damages resulting from such invasive work, arbitrary repairs, conversions and/or modifications to the device.

The safety-monitoring module must only be used when the enclosure is closed, i.e. with the front cover fitted.

## 2. Product description

### 2.1 Ordering code

This operating instructions manual applies to the following types:

#### SRB 301SQ-230V



Only if the information described in this operating instructions manual are realised correctly, the safety function and therefore the compliance with the Machinery Directive is maintained.

### 2.2 Special versions

For special versions, which are not listed in the order code below 2.1, these specifications apply accordingly, provided that they correspond to the standard version.

### 2.3 Destination and use

The safety-monitoring modules for integration in safety circuits are designed for fitting in control cabinets. They are used for the safe evaluation of the signals of positive break position switches for safety functions on sliding, hinged and removable safety guards as well as emergency stop control devices.

The safety function is defined as the opening of the enabling circuits 13-14, 23-24 and 33-34 when the inputs S11-S12 and/or S21-S22 are opened. The safety-relevant current paths with the output contacts 13-14, 23-24 and 33-34 meet the following requirements under observation of a B<sub>10d</sub> value assessment (also refer to "Requirements to DIN EN ISO 13849-1"):

- control category 4 – PL e to DIN EN ISO 13849-1
- corresponds to SIL 3 to DIN EN 61508-2
- corresponds to SILCL 3 to DIN EN 62061  
(corresponds to control category 4 to DIN EN 954-1)

To determine the Performance Level (PL) of the entire safety function (e.g. sensor, logic, actuator) to DIN EN ISO 13849-1, an analysis of all relevant components is required.

### 2.4 Technical data

Standards:	IEC/EN 60204-1, EN 60947-5-1; EN ISO 13849-1, IEC/EN 61508
Climate resistance:	EN 60068-2-78
Mounting:	Snaps onto standard DIN rail to EN 60715
Terminal designations:	EN 60947-1
Material of the housings:	Plastic, glass-fibre reinforced thermoplastic, ventilated
Material of the contacts:	AgSnO <sub>2</sub> , self-cleaning, positive drive
Weight:	250 g
Start conditions:	Automatic or start button
Feedback circuit (Y/N):	yes
Pull-in delay with reset button:	typ. 15 ms
Pull-in delay for automatic start:	typ. 30 ms, max. 35 ms
Drop-out delay in case of emergency stop:	typ. 20 ms, max. 25 ms
Drop-out delay on "supply failure":	48 VAC: typ. 100 ms 240 VAC: typ. 300 ms
Bridging in case of voltage drops:	48 VAC: typ. 70 ms 240 VAC: typ. 270 ms

#### Mechanical data:

Connection type:	Screw connection
Cable section:	min. 0.25 mm <sup>2</sup> / max. 2.5 mm <sup>2</sup>
Connecting cable:	rigid or flexible
Tightening torque for the terminals:	0.6 Nm
With removable terminals (Y/N):	yes
Mechanical life:	10 million operations
Electrical life:	Derating curve available on request
Resistance to shock:	10 g / 11 ms
Resistance to vibrations to EN 60068-2-6:	10 ... 55 Hz, amplitude 0.35 mm

#### Ambient conditions:

Ambient temperature:	–25 °C ... +45 °C
Storage and transport temperature:	–40 °C ... +85 °C
Protection class:	Enclosure: IP40 Terminals: IP20 Clearance: IP54

Air clearances and creepage distances to IEC/EN 60664-1:	4 kV/2 (basic insulation)
EMC rating:	to EMC Directive

#### Electrical data:

Contact resistance in new state:	max. 100 mΩ
Power consumption:	max. 2.8 VA
Rated operating voltage U <sub>e</sub> :	48 ... 240 VAC
Frequency range:	50 / 60 Hz
Max. fuse rating of the operating voltage:	
- primary side F1:	safety fuse, tripping current > 0.5 A;
- secondary side:	internal electronic fuse, tripping current > 0.12 A

#### Monitored inputs:

Cross-wire detection (Y/N):	Yes
Wire breakage detection (Y/N):	Yes
Earth leakage detection (Y/N):	Yes
Number of NO contacts:	0
Number of NC contacts:	2
Cable length:	1,500 m mit 1.5 mm <sup>2</sup> 2,500 m mit 2.5 mm <sup>2</sup>
Conduction resistance:	max. 40 Ω

**Outputs:**

Number of safety contacts:	3
Number of auxiliary contacts:	1
Number of signalling outputs:	0
Switching capacity of the safety contacts:	13-14; 23-24; 33-34: max. 250 V, 6 A ohmic (inductive in case of appropriate protective wiring); min. 10 V / 10 mA
Switching capacity of the auxiliary contacts:	41-42: 24 VDC / 2 A
Fuse rating of the safety contacts:	external (I <sub>k</sub> = 1000 A) to EN 60947-5-1 Safety fuse 8 A quick blow, 6 A slow blow
Fuse rating for the auxiliary contacts:	external (I <sub>k</sub> = 1000 A) to EN 60947-5-1 Safety fuse 2.5 A quick blow, 2 A slow blow
Utilisation category to EN 60947-5-1:	AC-15: 230 VAC / 6 A DC-13: 24 VDC / 6 A
Dimensions H x W x D:	100 mm x 22.5 mm x 121 mm
The data specified in this manual are applicable when the component is operated with rated operating voltage U <sub>e</sub> ±0%.	

**2.5 Safety classification**

Standards:	EN ISO 13849-1, IEC 61508, EN 60947-5-1
PL:	up to e
Control category:	up to 4
DC:	99% (high)
CCF:	> 65 points
PFH value:	≤ 2.00 × 10 <sup>-8</sup> /h
SIL:	up to 3
Service life:	20 years

The PFH value of 2.00 × 10<sup>-8</sup>/h applies to the combinations of contact load (current through enabling contacts) and number of switching cycles (n<sub>oply</sub>) mentioned in the table below. At 365 operating days per year and a 24-hours operation, this results in the below-mentioned switching cycle times (t<sub>cycle</sub>) for the relay contacts. Diverging applications upon request.

Contact load	n <sub>oply</sub>	t <sub>cycle</sub>
20 %	525,600	1.0 min
40 %	210,240	2.5 min
60 %	75,087	7.0 min
80 %	30,918	17.0 min
100 %	12,223	43.0 min

**3. Mounting**

**3.1 General mounting instructions**

Mounting: snaps onto standard DIN rails to EN 60715.

Snap the bottom of the enclosure slightly tilted forwards in the DIN rail and push up until it latches in position.

**3.2 Dimensions**

All measurements in mm.

Device dimensions (H/W/D): 100 x 22.5 x 121 mm  
with plugged-in terminals: 120 x 22.5 x 121 mm

**4. Electrical connection**

**4.1 General information for electrical connection**



As far as the electrical safety is concerned, the protection against unintentional contact of the connected and therefore electrically interconnected apparatus and the insulation of the feed cables must be designed for the highest voltage, which can occur in the device.



The electrical connection may only be carried out by authorised personnel in a de-energised condition.

**Wiring examples: see appendix**

**5. Operating principle and settings**

**5.1 LED functions**

- K1: Status channel 1
- K2: Status channel 2
- U<sub>i</sub>: Status internal operating voltage (LED is on, when the operating voltage on the terminals A1-A2 is ON and the fuse has not been triggered).

**5.2 Description of the terminals**

Voltages:	A1	48 ... 240 VAC
	A2	48 ... 240 VAC
Inputs:	S11-S12	Input channel 1 (+)
	S21-S22	Input channel 2 (-)
Outputs:	13-14	First safety enabling circuit
	23-24	Second safety enabling circuit
	33-34	Third safety enabling circuit
Start:	X2	Feedback circuit and external reset
	X3	Feedback circuit and automatic start
	41-42	Auxiliary NC contact

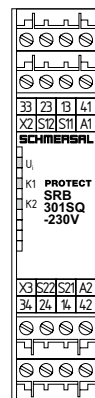

Fig. 1

**5.3 Notes**



Signalling outputs must not be used in safety circuits.



Due to the operating principle of the electronic fuse, the customer must check that no hazard is caused by an unexpected restart in circuits without reset button (automatic start).

6. Set-up and maintenance

6.1 Functional testing

The safety function of the safety-monitoring module must be tested. The following conditions must be previously checked and met:

1. Correct fixing
2. Check the integrity of the cable entry and connections
3. Check the safety-monitoring module's enclosure for damage.
4. Check the electrical function of the connected sensors and their influence on the safety-monitoring module and the downstream actuators

6.2 Maintenance

A regular visual inspection and functional test, including the following steps, is recommended:

1. Check the correct fixing of the safety-monitoring module
2. Check the cable for damages
3. Check electrical function



The device has to be integrated into the periodic check-ups according to the Ordinance on Industrial Safety and Health, however at least 1 × year.

**Damaged or defective components must be replaced.**

7. Disassembly and disposal

7.1 Disassembly

The safety-monitoring module must be disassembled in a de-energised condition only. Push up the bottom of the enclosure and hang out slightly tilted forwards.

7.2 Disposal

The safety-monitoring module must be disposed of in an appropriate manner in accordance with the national prescriptions and legislations.

8. Appendix

8.1 Wiring examples

**Dual-channel control, shown for a guard door monitor with two position switches A and B where one has a positive break contact; with external reset button (R) (Fig. 2)**

- Relay outputs: Suitable for 2-channel control, for increase in capacity or number of contacts by means of contactors or relays with positive-guided contacts.
- The control system recognises wire-breakage in the monitoring circuit.
- (R) = Feedback circuit

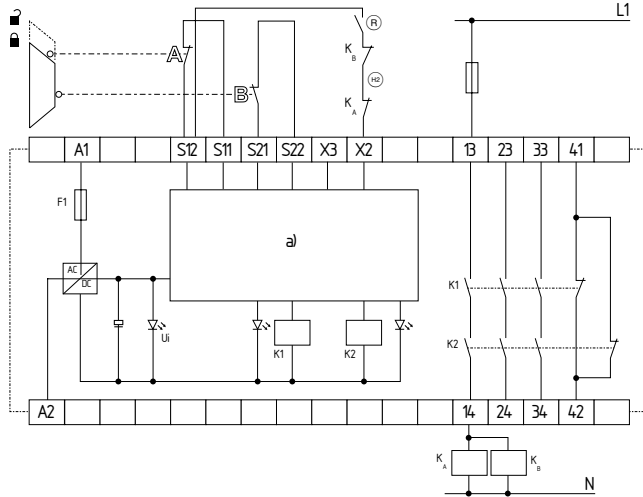

Fig. 2 a) Logic

8.2 Start configuration

**External reset button (with edge detection) (see Fig. 3)**

- The external reset button is integrated as shown.
- The safety-monitoring module is activated by the reset (after release) of the reset button (= detection of the trailing edge). Faults in the reset button, e.g. welded contacts or manipulations which could lead to an inadvertent restart, are detected in this configuration and will result in an inhibition of the operation.

**Automatic start (see Fig. 4)**

- The automatic start is programmed by connecting the feedback circuit to the terminals. If the feedback circuit is not required, establish a bridge.
- Caution: Not admitted without additional measure due to the risk of gaining access by stepping behind!
- Caution: Within the meaning of EN IEC 60204-1 paragraph 9.2.5.4.2 and 10.8.3, the operating mode "automatic start" is only restrictedly admissible. In particular, any inadvertent restart of the machine must be prevented by other suitable measures.

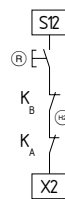

Fig. 3



Fig. 4

8.3 Sensor configuration

**Dual-channel emergency stop circuit with command devices to DIN EN ISO 13850 (EN 418) and EN 60947-5-5 (Fig. 5)**

- Wire breakage and earth leakage in the control circuits are detected.
- Cross-wire shorts between the control circuits are detected.
- Category 4 – PL e to DIN EN ISO 13849-1 possible.

**Dual-channel guard door monitoring circuit with interlocking device to EN 1088 (Fig. 6)**

- With at least one positive-break position switch
- Wire breakage and earth leakage in the control circuits are detected.
- Cross-wire shorts between the control circuits are detected.
- Category 4 – PL e to DIN EN ISO 13849-1 possible.

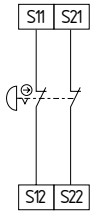

Fig. 5

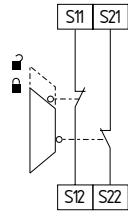

Fig. 6

8.4 Actuator configuration

**Single-channel control with feedback circuit (Fig. 7)**

- Suitable for increase in capacity or number of contacts by means of contactors or relays with positive-guided contacts.
- $\text{Ⓢ}$  = feedback circuit:  
If the feedback circuit is not required, establish a bridge.

**Dual-channel control with feedback circuit (Fig. 8)**

- Suitable for increase in capacity or number of contacts by means of contactors or relays with positive-guided contacts.
- $\text{Ⓢ}$  = feedback circuit:  
If the feedback circuit is not required, establish a bridge.

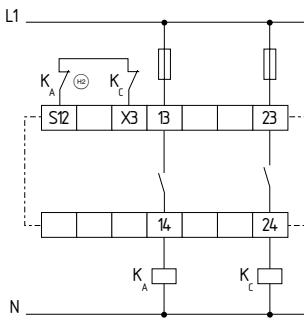

Fig. 7

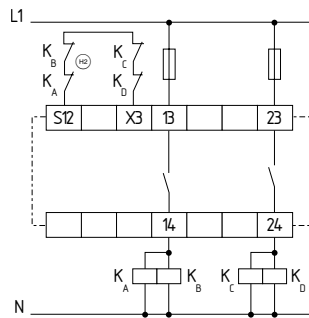

Fig. 8

**Differential control with feedback circuit (see Fig. 9)**

- Suitable for increase in capacity or number of contacts by means of contactors or relays with positive-guided contacts.
- $\text{Ⓢ}$  = feedback circuit:  
If the feedback circuit is not required, establish a bridge.

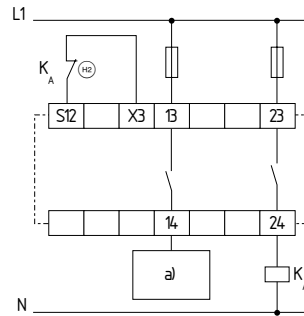

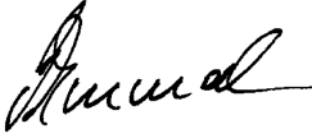

Fig. 9 a) Enabling signal controller

9. Declaration of conformity

9.1 EC Declaration of conformity

	
<b>EC Declaration of conformity</b>	
Translation of the original Declaration of Conformity	K.A. Schmersal GmbH & Co. KG Möddinghofe 30 42279 Wuppertal Germany www.schmersal.com
We hereby certify that the hereafter described safety components both in its basic design and construction conform to the applicable European Directives.	
<b>Name of the safety component:</b>	SRB 301SQ-230V
<b>Description of the safety component:</b>	Safety-monitoring module for emergency stop circuits and guard door monitoring
<b>Relevant EC-Directives:</b>	2006/42/EC-EC-Machinery Directive 2004/108/EC EMC-Directive
<b>Person authorized for the compilation of the technical documentation:</b>	Oliver Wacker Möddinghofe 30 42279 Wuppertal
<b>Notified body, which approved the full quality assurance system, referred to in Appendix X, 2006/42/EC:</b>	TÜV Rheinland Industrie Service GmbH Alboinstraße 56 12103 Berlin ID n°: 0035
<b>Place and date of issue:</b>	Wuppertal, March 10, 2014
SRB301SQ-230V-C-EN	
	Authorised signature <b>Philip Schmersal</b> Managing Director



The currently valid declaration of conformity can be downloaded from the internet at [www.schmersal.net](http://www.schmersal.net).



**K. A. Schmersal GmbH & Co. KG**  
Möddinghofe 30, D - 42279 Wuppertal  
Postfach 24 02 63, D - 42232 Wuppertal

Phone: +49 - (0)2 02 - 64 74 - 0  
Telefax: +49 - (0)2 02 - 64 74 - 1 00  
E-Mail: [info@schmersal.com](mailto:info@schmersal.com)  
Internet: <http://www.schmersal.com>