



EN Operating instructions. pages 1 to 12
Original

7 Wiring examples
7.1 Application example fail-safe delay timer. 8
7.2 Application examples safe standstill monitoring 9
7.3 Start configuration 10
7.4 Sensor configuration 10

8 Set-up and maintenance
8.1 Commissioning 11
8.2 Functional testing. 11
8.3 Behaviour in the case of faults. 11
8.4 Setting report 11
8.5 Maintenance 11

9 Disassembly and disposal
9.1 Disassembly. 11
9.2 Disposal 11

10 Appendix
10.1 Wiring/circuit information. 11

11 EU Declaration of conformity

Content

1 About this document
1.1 Function 1
1.2 Target group: authorised qualified personnel. 1
1.3 Explanation of the symbols used 1
1.4 Appropriate use 2
1.5 General safety instructions 2
1.6 Warning about misuse 2
1.7 Exclusion of liability 2

2 Product description
2.1 Ordering code 2
2.2 Special versions. 2
2.3 Purpose and use 2
2.4 Technical data 3
2.5 Derating / electrical lifespan of safety contacts 3
2.6 Safety classification 4

3 Mounting
3.1 General mounting instructions. 4
3.2 Dimensions 4

4 Electrical connection
4.1 General information for electrical connection. 4
4.2 Coding of connecting terminals 4

5 Operating principle and settings
5.1 Description of the terminals and LED indications 5
5.2 Adjustable applications 6
5.3 Changing setting or application 6

6 Diagnostic
6.1 LED indications 7
6.2 Faults 7
6.3 Warnings standstill monitoring function 7

1. About this document

1.1 Function
This operating instructions manual provides all the information you need for the mounting, set-up and commissioning to ensure the safe operation and disassembly of the the product. The operating instructions must be available in a legible condition and a complete version in the vicinity of the device.

1.2 Target group: authorised qualified personnel
All operations described in this operating instructions manual must be carried out by trained specialist personnel, authorised by the plant operator only.

Please make sure that you have read and understood these operating instructions and that you know all applicable legislations regarding occupational safety and accident prevention prior to installation and putting the component into operation.

The machine builder must carefully select the harmonised standards to be complied with as well as other technical specifications for the selection, mounting and integration of the components.

1.3 Explanation of the symbols used

 **Information, hint, note:**
This symbol indicates useful additional information.

 **Caution:** Failure to comply with this warning notice could lead to failures or malfunctions.
Warning: Failure to comply with this warning notice could lead to physical injury and/or damage to the machine.

1.4 Appropriate use

Products in Schmersal's range are not intended to be used by private end consumers.

The products described in these operating instructions are developed to execute safety-related functions as part of an entire plant or machine. It is the responsibility of the manufacturer of a machine or plant to ensure the correct functionality of the entire machine or plant.

The fail-safe delay timer must be exclusively used in accordance with the versions listed below or for the applications authorised by the manufacturer. Detailed information regarding the range of applications can be found in the chapter "Product description".

1.5 General safety instructions

The user must observe the safety instructions in this operating instructions manual, the country specific installation standards as well as all prevailing safety regulations and accident prevention rules.



Further technical information can be found in the Schmersal catalogues or in the online catalogue on the Internet: products.schmersal.com.

The information contained in this operating instructions manual is provided without liability and is subject to technical modifications.

There are no residual risks, provided that the safety instructions as well as the instructions regarding mounting, commissioning, operation and maintenance are observed.

1.6 Warning about misuse



In case of inadequate or improper use or manipulations of the fail-safe delay timer, personal hazards or damage to machinery or plant components cannot be excluded.

1.7 Exclusion of liability

We shall accept no liability for damages and malfunctions resulting from defective mounting or failure to comply with this operating instructions manual. The manufacturer shall accept no liability for damages resulting from the use of unauthorised spare parts or accessories.

For safety reasons, invasive work on the device as well as arbitrary repairs, conversions and modifications to the device are strictly forbidden, the manufacturer shall accept no liability for damages resulting from such invasive work, arbitrary repairs, conversions and/or modifications to the device.

The safety relay module is to be operated in an area in which access by personnel is restricted.

2. Product description

2.1 Ordering code

This operating instructions manual applies to the following types:

SRB-E-302FWS-TS-①-②

No.	Option	Description
①		Signalling output Y1 signals detected errors with a flashing code, see Section 6
	OEM19	Signalling output Y1 signals detected errors with a high signal (+24 V/DC)
②		Plug-in screw clamps: single wire (rigid) or fine wire (flexible): 0.2 ... 2.5 mm ² ; fine wire with ferrule: 0.25 ... 2.5 mm ²
	CC	Plug-in cage clamps: single wire (rigid) or fine wire (flexible): 0.2 ... 1.5 mm ² ; fine wire with ferrule: 0.25 ... 1.5 mm ²



Only if the action described in these operating instructions is carried out correctly will the safety function be safeguarded, including compliance with the Machinery Directive.

2.2 Special versions

For special versions, which are not listed in the order code below 2.1, these specifications apply accordingly, provided that they correspond to the standard version.

2.3 Purpose and use

Safe pull-in delay function

The fail-safe delay timers for integration in safety circuits are designed for fitting in control cabinets. They serve as a reliable means of evaluating actuation signals and delayed authorisation of protective equipment.

The safety function is defined as deactivation of the fail-safe outputs Q1 and 13/14 (17/18), 23/34 (27/28) when inputs S12 and/or S22 are opened and the fail-safe outputs are activated when the set activation delay time has elapsed.

Safe standstill monitoring function

The fail-safe standstill monitor is designed for control cabinet mounting. Standstill monitors serve for the fail-safe detection of the machine standstill and control of solenoid interlocks. If the safety control module has detected standstill, a solenoid interlock can be operated using the fail-safe outputs Q1, 13/14 (17/18), 23/34 (27/28).

The signals from one or two proximity switches are used to detect standstill. Optionally, an additional standstill signal can be monitored. The additional standstill signal can be derived from an already available standstill signal of the machine, e.g. evaluation of a tachogenerator by a PLC or the standstill output of a frequency converter.

Taking account of a PFH value assessment, the safety-relevant current paths meet the following requirements (see also chapter 2.6 "Safety classification")

- Category 4 - PL e to EN ISO 13849-1
- corresponds to SIL 3 to IEC 61508 and EN 62061

To determine the Performance Level (PL) to EN ISO 13849-1 of the entire safety function (e.g. sensor, logic, actuator), an assessment of all relevant components is required.



The entire concept of the control system, in which the safety component is integrated, must be validated to the relevant standards.

2.4 Technical data

General data

Standards:	EN 60204-1, EN 60947-5-1, EN ISO 13849-1, IEC 61508, EN 62061
EMC rating:	to EMC Directive
Air clearances and creepage distances:	to EN 60664-1
Mounting:	standard rail to EN 60715
Terminal designations:	EN 60947-1

Electrical characteristics:

Rated operating voltage U_e :	24 VDC -20%/+20%, residual ripple max. 10%
---------------------------------	---

Frequency range:	-
------------------	---

Mains adapter/power supply: An ES1 or PELV/SELV mains adapter must be used as a voltage source or be ensured by means of additional measures so that the output voltage of the power adapter in the event of an error does not exceed 60 V. Mains power supply must harmonise with device safety (characteristic/melting property) so that triggering is ensured.

Power consumption:	3 W (+ load of the safety outputs)
--------------------	------------------------------------

Fuse rating for the operating voltage:	we recommend a circuit breaker type Z (max. 16 A) or a fine fuse (max. 15 A, delayed action)
--	--

UL Rating of external fuse:	max. 16 A, only use fuses in accordance with UL 248 series
-----------------------------	--

Insulation values to EN 60664-1:	
Rated insulation voltage U_i :	

- Safety contacts:	250 V
- Safety outputs:	50 V

Rated impulse withstand voltage U_{imp} :	
- Safety contacts 17-18, 27-28:	6 kV
- Safety output Qt1:	0.8 kV

Overvoltage category:	III
Degree of pollution:	2

Drop-out delay on "supply failure":	< 10 ms
Bridging in case of voltage drops:	typ. 5 ms

Readiness after switching on voltage:	< 1.5 sec.
Frequency measurement tolerance:	< 2%

Time measurement tolerance:	2% + 30 ms
-----------------------------	------------

Control current circuits/inputs:

Inputs S12, S22:	24 VDC / 8 mA
Max. input frequency:	6000 Hz

Inputs X2, X3, X7:	24 VDC / 8 mA
Clock outputs S11, S21:	> 20 VDC, 10 mA per output

Cable length:	1500 m with 1.5 mm ² , 2500 m with 2.5 mm ²
---------------	--

Conduction resistance:	max. 40 Ω
Classification:	ZVEI CB24I, 2016

Sink:	C1	Source:	C1	C2	C3
Test pulse duration, max.:	3 ms				
Test pulse interval, min.:	8 ms				

Input resistance, min.:	3 kΩ
Input capacity at 10 kHz, max.:	1 nF

Relay outputs:

Switching capacity of the safety contacts:	13/14 (17-18), 23/24 (27-28): max. 250 V, 6 A ohmic, min. 10 VDC / 10 mA (Derating see 2.5)
--	--

Fuse rating of the safety contacts:	external ($I_k = 1000 A$) to EN 60947-5-1
-------------------------------------	--

Safety fuse 10 A quick blow, 6 A slow blow

Utilisation category to EN 60947-5-1:	AC-15: 230 V / 4 A DC-13: 24 V / 4 A
---------------------------------------	---

Electrical life:	refer to 2.5
Mechanical life:	10 million operations

Semi-conductor outputs:

Switching capacity of the safety outputs:	Q1: max. 2 A
Voltage drop:	< 0.5 V

Leakage current:	< 1 mA
Max. fuse rating of the safety outputs:	refer to "Operating voltage"

Test impulse of the safety outputs:	< 1 ms (negative), < 100 μs (positive)
-------------------------------------	---

Utilisation category to EN 60947-5-1:	DC-13: 24 V / 2A
Switching capacity of signaling outputs: semi-conductor outputs Y1, Y2:	24 VDC/100 mA

Fuse rating of the signalling outputs:	internal electronic trip, tripping current > 100 mA
--	--

Electrical life:	(Derating refer to 2.5)
Max. switching cycles / minute:	20

Inductive consumers:	provision is to be made for suitable protective wiring for suppression
----------------------	--

Classification:	ZVEI CB24I, 2016
-----------------	------------------

Source:	C1	Sink:	C1	Test pulse duration, min.:	140 μs	
					Test pulse duration, max.:	480 μs

Test pulse interval, min.:	10 ms
Capacitive load, max.:	660 nF

Ratio test pulse duration / test pulse interval:	5%
--	----

Mechanical data:

Connection type:	refer to 2.1
Cable section:	refer to 2.1

Connecting cable:	rigid or flexible
Tightening torque for the terminals:	0.5 Nm

Material of enclosure:	glass-fibre reinforced thermoplastic, ventilated
Weight:	180 g

Ambient conditions:

Ambient temperature:	-25°C ... +60°C (non condensing)
Storage and transport temperature:	-40°C ... +85°C (non condensing)

Degree of protection:	Enclosure: IP40 Terminals: IP20 Clearance: IP54
-----------------------	---

Resistance to shock:	30 g / 11 ms
Resistance to vibrations	

to EN 60068-2-6:	10 ... 55 Hz, amplitude 0.35 mm
Altitude:	max. 2,000 m

2.5 Derating / electrical lifespan of safety contacts

No derating with individual installation of modules.

Derating on request if several modules are installed one after the other without spacing and with maximum output load and ambient temperatures.

Electrical life of the safety contacts

Operations

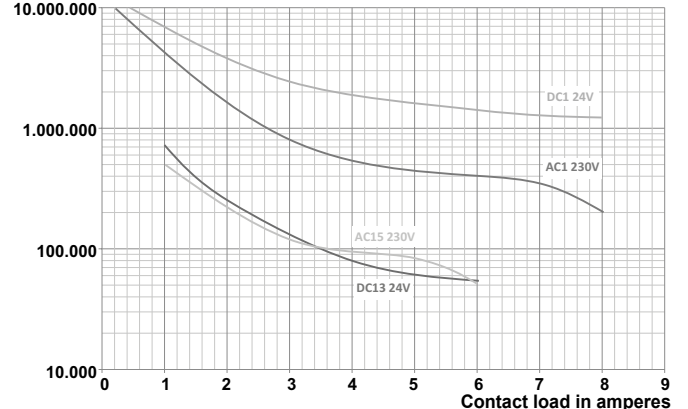

2.6 Safety classification

2.6.1 Safety classification of semi-conductor output

Standards:	EN ISO 13849-1, IEC 61508, EN 62061
PL:	e
Category:	4
PFH _D :	≤ 2.66 x 10 ⁻⁹ / h
PFD _{avg} :	≤ 2.42 x 10 ⁻⁵
SIL:	suitable for SIL 3 applications
Mission time:	20 years

2.6.2 Classification of relay output

Standards:	EN ISO 13849-1, IEC 61508, EN 62061
PL:	e
Category:	4
DC:	high
CCF:	> 65 points
PFH _D :	≤ 1.25 x 10 ⁻⁸ / h
PFD _{avg} :	≤ 5.3 x 10 ⁻⁵
SIL:	suitable for SIL 3 applications
Mission time:	20 years

The PFH value of 1.25 × 10⁻⁸/h applies to the combinations of contact load (current through enabling contacts) and number of switching cycles (n_{oply}) mentioned in the table below. At 365 operating days per year and a 24-hours operation, this results in the below-mentioned switching cycle times (t_{cycle}) for the relay contacts.

Contact load	n _{oply}	t _{cycle}
20 %	880,000	0.6 min
40 %	330,000	1.6 min
60 %	110,000	5.0 min
80 %	44,000	12.0 min
100 %	17,600	30.0 min

Diverging applications upon request.

3. Mounting

3.1 General mounting instructions

Mounting: snaps onto standard rails to EN 60715.

Hook bottom of enclosure in standard rail and push down until it engages in position.



To avoid EMC disturbances, the physical ambient and operational conditions at the place where the product is installed, must meet the provisions laid down in the paragraph "Electromagnetic Compatibility (EMC)" of EN 60204-1.

Avoid laying proximity switch connection cables in areas where strong interference signals are present (e.g. frequency converters or cable leads from powerful electric motors), the utilisation of shielded cables may be necessary.



Mount proximity switches / pulse generators mechanically separated from each other (not on the same mounting angle). The toothed wheel (encoder) must be mounted on the shaft with a positive joint free of slip.

3.2 Dimensions

Device dimensions (H/W/D): 98 x 22.5 x 115 mm

4. Electrical connection

4.1 General information for electrical connection



The electrical connection may only be carried out by authorised personnel in a de-energised condition.



If mains unit is a new installation or a replacement, the connector of the output level must be removed and correct connection of the power supply (A1) must be checked.

Settle length x of the conductor:

- on screw terminals: 7 mm
- on cage clamps of type s or f: 10 mm



4.2 Coding of connecting terminals

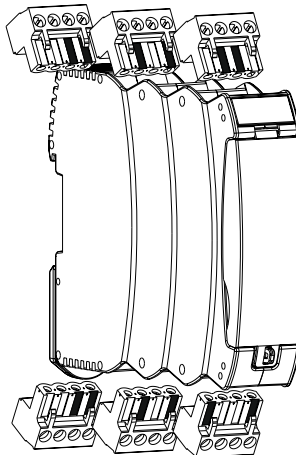

5. Operating principle and settings

5.1 Description of the terminals and LED indications

Clip	Function	LED	Function
A1	Operating voltage + 24 VDC	RUN	Operating voltage OK RUN mode For flash code, see section 5.3
A2	Operating voltage 0 V		
		ERR	Error code refer to part 6
X2	Reset input		
X3	Start input		
X7	Input additional standstill signal		
S11	Test pulse outputs		
S21	Input channel 1	In 1	High level at S12 For flash code, see section 6
S22	Input channel 2	In 2	High level at S22 For flash code, see section 6
Y1	Diagnostic output		For flash code, see section 6
Y1 (OEM19)	Output Error message		0 = Status OK 1 = Error detected
Y2	Signalling output (NO)		
13/14 (17/18), 23/34 (27/28)	Safety contacts	Out 1	Outputs activated For flash code, see section 6
Q1	Safety output	Out 2	Outputs activated For flash code, see section 6

Standstill monitoring function with pulse generator

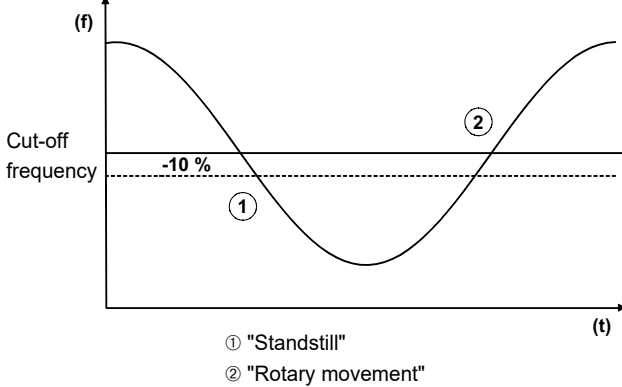

Standstill monitoring function with pulse generator and standstill signal

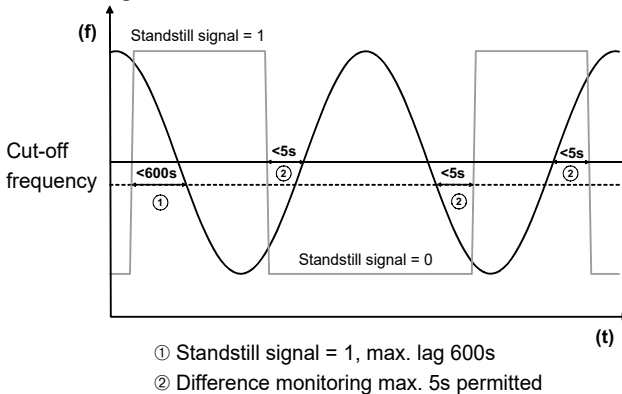

Fail-safe delay timer function

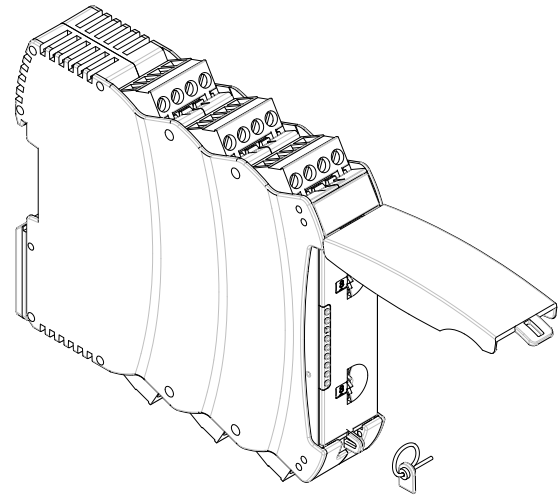
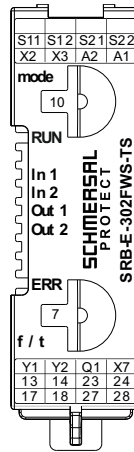
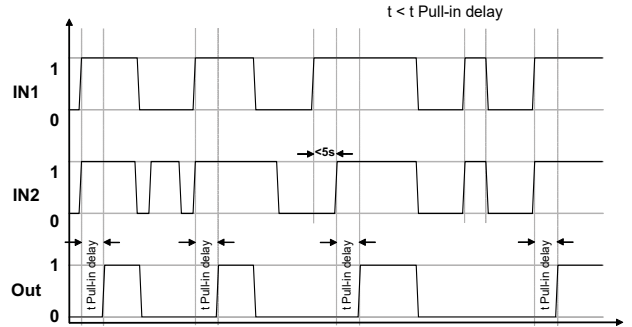

Adjustment of application using rotary "mode" switch

- Open front transparent cover (see fig.).
- Opening is carried out by lifting side with lock.
- Select desired application using rotary mode switch (1 ... 15) by turning up or down (see 5.3).
- Set pull-in delay or cut-off frequency by turning the f/t rotary switch up or down (see 5.3).
- After performing setting, close front cover again.
- The front cover can be secured with a seal for protection against unintentional opening



Only touch the components after electrical discharge!

5.2 Adjustable applications

Adjustable applications standstill monitoring function:

Rotary switch (mode)				Rotary knob f / t	
Pos.	1 or 2 sensors	2 sensors with level monitoring	Standstill signal	Pos.	Cut-off frequency
1	Yes	–	No	1	0.5 Hz
2	–	Yes	No	2	1 Hz
3	Yes	–	Yes	3	2 Hz
C	Configuration mode			4	3 Hz
				5	4 Hz
				6	5 Hz
				7	8 Hz
				8	10 Hz

Adjustable applications delay timer function:

Rotary switch (mode)				Rotary knob f / t				
Pos.	Contact configuration Synchronism < 5 s	Cross-wire monitoring	Timebase	Pos.	Time 1 (s)	Time 2 (s)	Time 3 (s)	Time 4 (s)
				1	0.5	35	120	300
				2	1.0	40	130	400
				3	1.5	45	140	500
4	NC / NO	Yes	Time 1	4	2.0	50	150	600
5	NC / NO	Yes	Time 2	5	2.5	55	160	700
6	NC / NO	Yes	Time 3	6	3	60	170	800
7	NC / NO	Yes	Time 4	7	4	65	180	900
8	NO / NO	No	Time 1	8	5	70	190	1000
9	NO / NO	No	Time 2	9	8	75	200	1200
10	NO / NO	No	Time 3	10	10	80	210	1400
11	NO / NO	No	Time 4	11	12	85	220	1600
12	NO / NO	Yes	Time 1	12	15	90	230	1800
13	NO / NO	Yes	Time 2	13	18	95	240	2000
14	NO / NO	Yes	Time 3	14	20	100	250	2300
15	NO / NO	Yes	Time 4	15	25	105	260	2600
C	Configuration mode			C	30	110	270	3000

5.3 Changing setting or application

Description / procedure	Rotary (mode) switch	Rotary knob (f / t)	System response	LED indications			
				RUN	In 1	In 2	Out
Factory setting	Position 3	1 Hz	Ready for application	-	-	-	-
Switch operating voltage on			Without connected sensors!	Lights up	-	-	-
	Turn to position C		Application is deleted	Lights up	Flashes	Flashes	Flashes
Setting cycle active			Application is deleted	-	-	-	-
			No valid application saved	Flashes	-	-	-
SRB-E ready for new applications							
Select cut-off frequency or pull-in delay		Set frequency / time 1-C		Flashes	-	-	-
Select application	Select desired application (1-15). (Time window for setting procedure approx. 3 sec.)		New application will be loaded	Lights up	-	-	-
Setting cycle active				Lights up	Lights up	-	-
				Lights up	Lights up	Lights up	-
				Lights up	Lights up	Lights up	Lights up
Ready for operation	The desired application is configured		Adopt new application	Lights up	-	-	-
Switch off operating voltage and connect wires according to selected application -> SRB-E... ready for operation							

6. Diagnostic

6.1 LED indications

LED	Function	Display type
RUN	Ready for operation	Continuously lit
	Not a valid application	Flashes
In 1	Signal on input S12	Continuously lit
	Second channel, input S22 has not opened	Flashes slowly
In 2	Signal on input S22	Continuously lit
	Second channel, input S12 has not opened	Flashes slowly
Out 1	Standstill / time elapsed	Continuously lit
Out 2	Standstill / time elapsed, input X3 open	Flashes quickly
In1 – Out2	Switch-on delay active	Flashing light

Single flashing of all LEDs with mains on

6.2 Faults

Malfunctions and fault causes are displayed with the ERR-LEDs via short and long flashing signals

LED + Output	Error cause	Long flash	Short flash	
ERR Y1	Operating voltage too low	1	1	
	Operating voltage too high	1	2	
	Invalid rotary switch setting	1	3	
	External voltage on output Q1	1	5, 7, 9	
	Termination to GND on output Q1	2	2	
	Cross-wire between inputs	2	4	
	Undefined level on			
	X2	3	4	
	X3	3	5	
	X7	3	9	
	S12	2	9	
	S22	3	1	
	Rotary switch > 30 sec. to position C	6	8	
	Application changed and activation of operating voltage	LEDs flash quickly: RUN, In 1, In 2, Out		
Application was changed during active operation	LEDs flash quickly: ERR, In 1, In 2, Out			
Other fault codes: Consult technical sales dept. at Schmersal				

6.3 Warnings standstill monitoring function

Warning messages are indicated by means of short and long flashes on the ERR LED.

LED + Output	Error cause	Long flash	Short flash
ERR Y1	Frequency deviation between the two channels (> 20%)	4	4
	Maximum frequency (6 KHz) reached	4	5
	Limit dropped below, low signal on input S12 and S22 (see 10.1)	4	6
	Standstill signal static or sensor faulty	4	7

Input X2, delete warning messages

All warning messages that have occurred due to asynchronous signals can be cleared by pressing the Reset button.



OEM19 version:

The signalling output Y1 signals detected errors with a high signal (+ 24 V/DC).

7. Wiring examples

7.1 Application example fail-safe delay timer

Two-channel operation with Start function

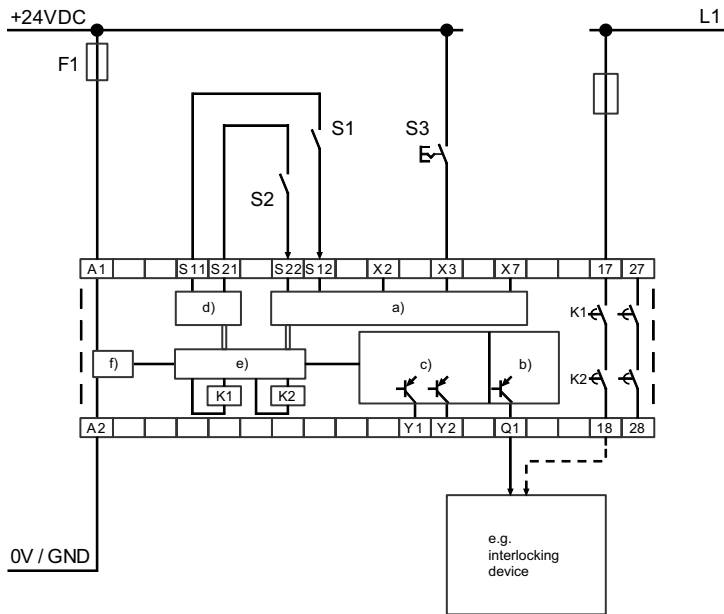

Key

S1/S2: Safety input contacts
S3: Start button

- a) Safety inputs
- b) Safety outputs
- c) Signalling outputs
- d) Clock outputs
- e) Processing
- f) Power

Function description of actuation:

- Upon actuation of inputs S12 and S22 (closing of contacts S1 and S2) the set activation delay timer is started.
- If the contacts S1 or S2 are opened and closed again before the time has elapsed, the time is restarted.
- Once the period has elapsed, the safety outputs with input X3 can be activated.
- If the safety outputs are to be activated automatically when the time has elapsed, input X3 must be switched to + 24 VDC.

Function description of safety outputs:

- It is possible for e.g. a safety door to be actuated with the two delayed safety contacts 17/18 and 27/28 or with the fail-safe semi-conductor output Q1.



Signalling outputs must not be used in safety circuits.

7.2 Application examples safe standstill monitoring

Two-channel operation with level monitoring and Start function

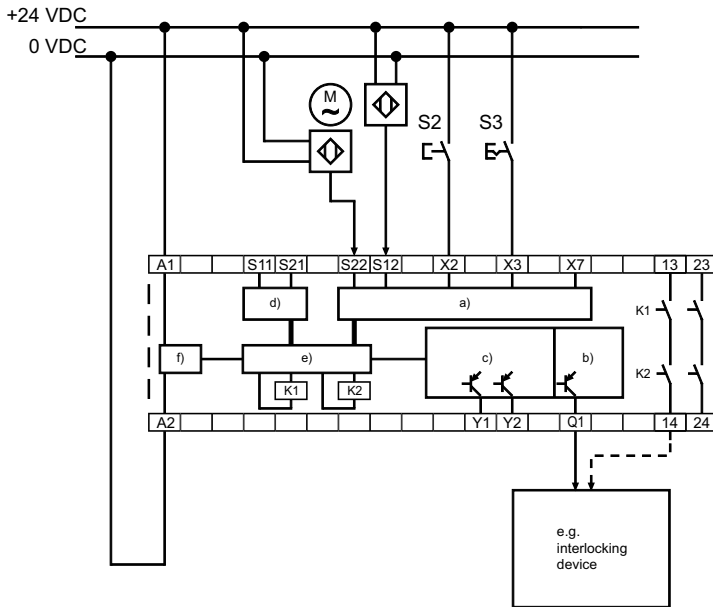

- Key**
 S1: Additional standstill signal
 S2: Reset button (delete warning messages)
 S3: Start button
- a) Safety inputs
 b) Safety outputs
 c) Signalling outputs
 d) Clock outputs
 e) Processing
 f) Power

Function description with level monitoring:

- The inputs S12 and S22 monitor the pulses from the sensors connected and compare them with the cut-off frequency set.
- The frequencies from the two sensors are continuously compared. A difference > 20% is detected as an error!
- After dropping below the cut-off frequency the safety output can be activated using input X3.
- If the safety outputs are to be activated automatically, the input X3 must be connected to + 24 VDC.

Function description of safety outputs:

- Using the two safety contacts 13/14 and 23/24 or using the safe semiconductor output Q1, e.g. a safety door can be operated.

Two-channel operation with additional standstill signal and Start function

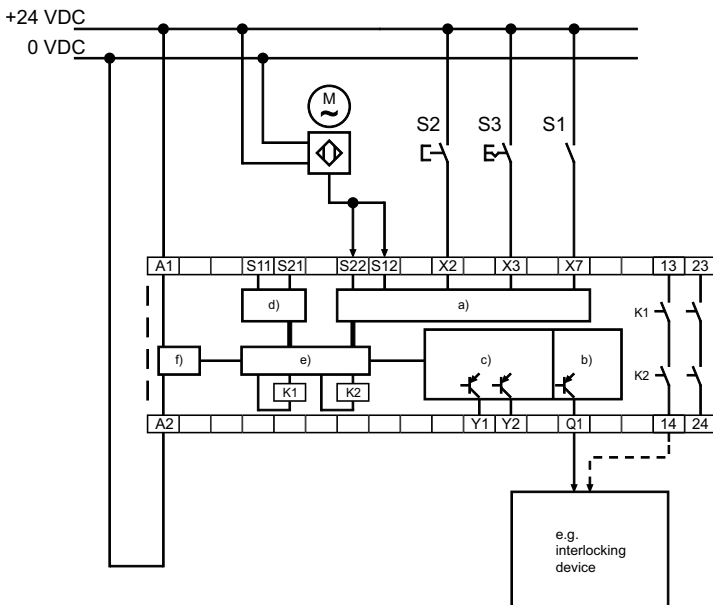

- Key**
 S1: Additional standstill signal
 S2: Reset button (delete warning messages)
 S3: Start button
- a) Safety inputs
 b) Safety outputs
 c) Signalling outputs
 d) Clock outputs
 e) Processing
 f) Power

Function description with additional standstill signal:

- The inputs S12 and S22 monitor the pulses from the sensor connected and compare them to the cut-off frequency set.
- The input X7 monitors the standstill signal function as a function of the frequency from the sensor. A difference > 5 s is detected as an error!
- After dropping below the cut-off frequency and standstill signal (= 1), the safety outputs can be activated using input X3.
- If the safety outputs are to be activated automatically, the input X3 must be connected to + 24 VDC.

Function description of safety outputs:

- Using the two safety contacts 13/14 and 23/24 or using the safe semiconductor output Q1, e.g. a safety door can be operated.

7.3 Start configuration

7.3.1 Start/Autostart

- The safety outputs can be activated after the switch-on delay has elapsed or the cut-off frequency has been dropped below.
- With autostart, X3 must be bridged to S11, S21 or +24 VDC

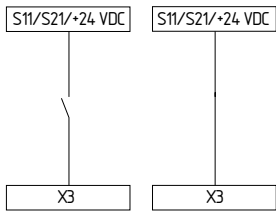

7.3.2 Reset warning message

- All warning messages that have occurred due to asynchronous signals can be deleted by pressing the Reset button. The reset function is triggered on releasing the button.

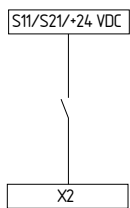

7.4 Sensor configuration

Single channel signal processing

(Category 1 – PL c to EN ISO 13849-1 possible.)

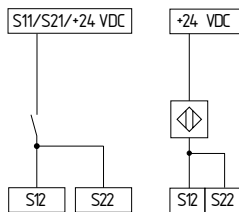

Rotary knob position	Function
8, 9, 10, 11	NO Time monitoring
1	Standstill monitoring

Dual channel signal processing without cross-circuit monitoring

(Category 4 - PL e to EN ISO 13849-1 only possible with protective wiring)

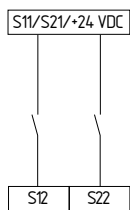

Rotary knob position	Function
8, 9, 10, 11	NO / NO Time monitoring

Dual channel signal processing with cross-circuit monitoring

(Category 4 – PL e to EN ISO 13849-1 possible)

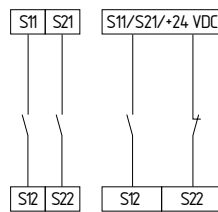

Rotary knob position	Function
12, 13, 14, 15	NO / NO time monitoring
4, 5, 6, 7	NC / NO time monitoring

Two-channel signal processing with standstill signal

(Category 3 – PL d to EN ISO 13849-1 possible)

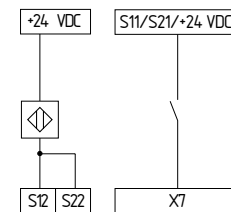

Rotary knob position	Function
3	Standstill monitoring

Two-channel signal processing

(Lay wires to the pulse generators separately and with protection, category 3 - PL e according to EN ISO 13849-1 can be achieved)

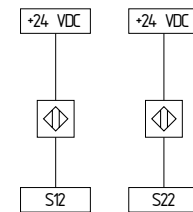

Rotary knob position	Function
1	Standstill monitoring

Two-channel signal processing with level monitoring

(Lay wires to the pulse generators separately and with protection, category 4 - PL e according to EN ISO 13849-1 can be achieved)

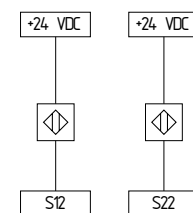

Rotary knob position	Function
2	Standstill monitoring

8. Set-up and maintenance

8.1 Commissioning

The safety relay module features degree of protection IP54 for installation in a switch cabinet.

The safety relay module is delivered ready for operation.

8.2 Functional testing

The safety function of the safety-monitoring module must be tested. The following conditions must be previously checked and met:

1. Correct fixing
2. Check the integrity of the cable entry and connections
3. Check the safety-monitoring module's enclosure for damage.
4. Check the electrical function of the connected sensor technology and their influence on the safety-monitoring module and the downstream actuators.

The safety relay module features self-test functions. If a fault is detected, the system adopts a safe mode and leads, if necessary, to undelayed deactivation of all safety outputs.

8.3 Behaviour in the case of faults

In the event of a fault the following procedure is recommended:

1. Identify faults according to flash codes from chapter 6.2.
 2. Rectify the fault if it is described in the table.
 3. Switch operating voltage off and on and erase fault mode.
- If fault could not be rectified, please contact the manufacturer.

8.4 Setting report

This report regarding the setting of the device must be completed accordingly by the customer and enclosed in the technical documentation of the machine.

The setting report must be available whenever a safety check is performed.

Company: _____

The safety-monitoring module is used in the following machine:

_____	_____	_____
Machine no.	Machine type	Module n°

Configured application (mode): _____

Set drop-out delay (t): _____

Cut-off frequency set (f): _____

_____	_____
Set on (date)	Signature of the responsible person

8.5 Maintenance

A regular visual inspection and functional test, including the following steps, is recommended:

1. Check the correct fixing of the safety-monitoring module
2. Check the cable for damages
3. Check electrical function



If a manual functional check is necessary to detect a possible accumulation of faults, then this must take place during the intervals noted as follows:

- at least every month for PL e with category 3 or category 4 (according to EN ISO 13849-1) or SIL 3 with HFT (hardware fault tolerance) = 1 (according to EN 62061);
- at least every 12 months for PL d with category 3 (according to EN ISO 13849-1) or SIL 2 with HFT (hardware fault tolerance) = 1 (according to EN 62061).

Damaged or defective components must be replaced.

9. Disassembly and disposal

9.1 Disassembly

The safety control module is only to be removed in a de-energised condition.

9.2 Disposal

The safety control module must be disposed of in an appropriate manner in accordance with the national regulations and laws.

10. Appendix

10.1 Wiring/circuit information

Two-channel signal processing with level monitoring

The proximity switches must be attached at a disc cam so at least one proximity switch is always actuated.

This can be realised by a minimum 1:1 division of the disc cam. When the proximity switches are correctly installed, the following unique signal sequence should be obtained by the utilisation of the switching hysteresis of the proximity switches during the rotation of the disc cam.

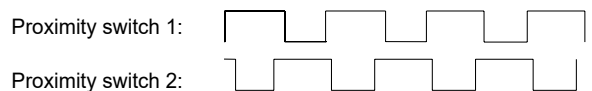

The adjustment of the proximity switches is facilitated, when the cam has a 2:1 division (or higher).

Example cam

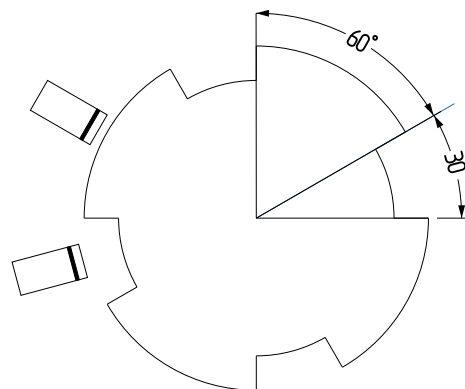

Proximity switches / pulse generators

Use PNP-switching sensors with normally open function.

11. EU Declaration of conformity

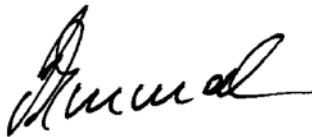
EU Declaration of conformity		
Original	K.A. Schmersal GmbH & Co. KG Mödinghofe 30 42279 Wuppertal Germany Internet: www.schmersal.com	
We hereby certify that the hereafter described components both in their basic design and construction conform to the applicable European Directives.		
Name of the component:	SRB-E-302FWS-TS	
Type:	See ordering code	
Description of the component:	Fail-safe delay timer, safe standstill monitor	
Relevant Directives:	Machinery Directive	2006/42/EC
	EMC-Directive	2014/30/EU
	RoHS-Directive	2011/65/EU
Applied standards:	EN ISO 13849-1:2023, EN ISO 13849-2:2012, IEC 61508 parts 1-7:2010	
Notified body for Type Examination:	TÜV Rheinland Industrie Service GmbH Am Grauen Stein, 51105 Köln ID n°: 0035	
EC-Type Examination Certificate:	01/205/5635.01/25	
Person authorised for the compilation of the technical documentation:	Oliver Wacker Mödinghofe 30 42279 Wuppertal	
Place and date of issue:	Wuppertal, September 23, 2025	
SRB-E-302FWS-TS-G-EN		
	Authorised signature Philip Schmersal Managing Director	



The currently valid declaration of conformity can be downloaded from the internet at products.schmersal.com.

